









120 SE

| | | 120 SE |
|---|--|------------------|
|  | Working height | 11.75 m |
| | Platform height | 9.75 m |
|  | Capacity | 318 kg |
| | Number of persons (indoor/outdoor) | 2/1 |
| | Basket (width and length) | 3.18 x 1.15 m |
|  | 1. Overall width | 1.17 m |
| | 2. Overall length | 2.44 m |
| | 3. Overall height | 2.39 m |
| | 4. Overall length (with extension) | 3.33 m |
| | 5. Overall height when folded | 1.80 m |
| | 6. Interior turning circle | 0 m |
| | 7. Exterior turning circle | 2.29 m |
| | 8. Ground clearance | 10 cm |
| | 9. Wheelbase | 1.85 m |
|  | Speed of forward movement | 3.50 kph |
| | Working speed | 0.80 kph |
| | Speed (raise/lower) | 57/35 secs |
|  | Maximum slope accessible | 25% |
|  | Tyres (solid non marking) | 38 x 13 x 28 cm |
| | Driving wheels | 2 (front) |
| | Steering/directional wheels | 2 (front) |
|  | Weight | 2781 kg |
| | (varies according to options & standards of the country) | |
|  | Batteries | 225 Ah / 4 x 6 V |
| | Integrated charger | 19 Ah / 24 V |

Standard equipment

| |
|--|
| Proportional switches/levers |
| Forward movement possible at maximum height |
| Sound and visual alarm in case of excessive slant and overload |
| Integrated charger |
| Emergency manual descent |
| Negative braking system |
| Sound warning system inside the platform |
| Hour meter |
| Indication of state of charge of batteries |
| Hooks for sling loading/lifting |
| Integrated diagnostic aid |
| Predisposition 220V |
| Anti roll system |
| Tyres with non-marking edges |
| Access gate for platform |
| Folding guardrails |
| Multiple disc brakes on rear wheels |
| Removable control box |
| Flashing lights |

Optional equipment

| |
|---|
| Working light |
| Predisposition of air |
| Special paint |
| Warning signal for all movements |
| Initial certificate of verification prior to entry into service |
| Safety harness |

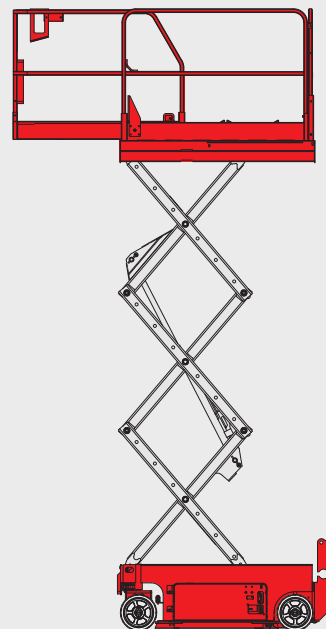
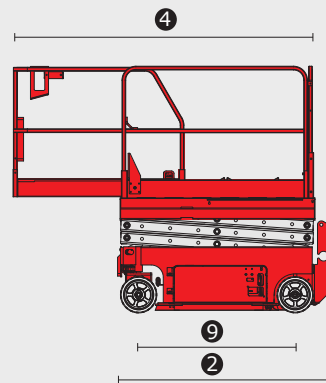
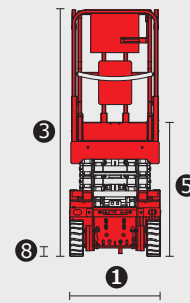

This brochure describes versions and configuration options for Manitou products which may be fitted with different equipment. The equipment described in this brochure may be standard, optional or not available depending on version. Manitou reserves the right to change the specifications shown and described at any time and without prior warning. The manufacturer is not liable for the specifications given. For more information, contact your Manitou dealer. Non-contractual document. Product descriptions may differ from actual products. List of specifications is not comprehensive. The logos and visual identity of the company are the property of Manitou and may not be used without authorisation. All rights reserved. The photos and diagrams contained in this brochure are provided for information only.

MANITOU BF SA - Limited company with board of directors - Share capital: 39,547,824 euros - 857 802 508 RCS Nantes

